

Linear

LINE-S RGB Fixture Guide

KKDC



Indoor | Surface | RGB output

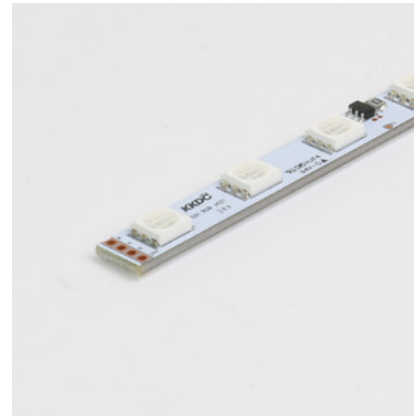

Key applications

- ✓ Architectural detail
- ✓ Cabinet & furniture
- ✓ Cove lighting
- ✓ Display case
- ✓ Indirect lighting
- ✓ Interior
- ✓ Mirror back lighting
- ✓ Retail display
- ✓ Shelving display
- ✓ Special effect

Key features

- ✓ Custom lengths
- ✓ Constant Voltage (CV)
- ✓ Diffusion: spotting
- ✓ IP40 dry area
- ✓ RGB

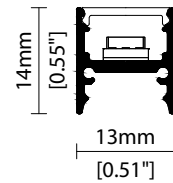

MOUNTING METHODS



KKCP-10 Concealed clip

Linear

LINI-S RGB

Specification sheet

KKDC



Dimensions	H14/W13/L97-2014mm (H0.55/W0.51/L3.81-79.29in)
PCB Cut-point	83.3mm increment/2000mm max (3.28in increment/78.74in max)
LED Pitch	13.9mm-72LED/m (0.55in - 22LED/ft)
Chip	RGB
Cover/Optics	Clear (105°)/Diffused (110°)
CCT	Red 620-625nm/Blue 455-460nm/Green 520-525nm
LED binning	5nm tolerance
CRI	N/A
Lifetime	50,000 hours @ 25°C (50,000 hours @ 77°F)
Operating temp	T _a = -25 to 50°C (T _C max = 76°C) T _a = -13 to 122°F (T _C max = 169°F)
IP Rating	IP40
Finish	Silver anodised
Mounting	Surface mounting via concealed clips
Power feed	Hardwire tails or male/female connectors
Control	DMX/DALI



Power consumption	Supply voltage	Supply current
15.6W/m (4.75W/ft)	24V DC	0.65A/m (0.20A/ft)

Clear Cover

Red: 134lm/m (41lm/ft)
Green: 284lm/m (87lm/ft)
Blue: 46lm/m (14lm/ft)
RGB: 423lm/m (129lm/ft)

Diffused Cover

Red: 94lm/m (29lm/ft)
Green: 202lm/m (68lm/ft)
Blue: 33lm/m (10lm/ft)
RGB: 292lm/m (89lm/ft)

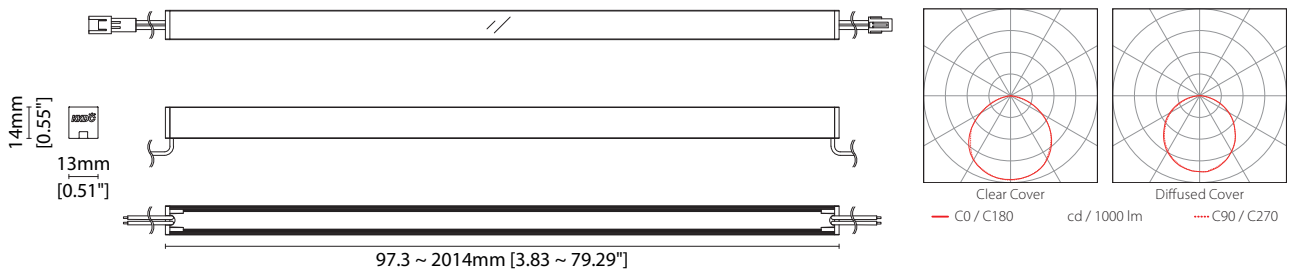

Data derived from production samples tested to UKAS/IESNA LM-79-08 standards.

See KKDC website for product document updates.

www.kkdc.lighting

LINISRGBS-03.03EN-20240514

FIXTURE

Model	Finish ¹	Cover ²	Grade	LED	Colour (CCT)	Length Availability ³	IP	Cable Length	Power Feed ⁴	Input									
LINE-S	LS	Silver Anodised (grey endcaps)	SA	Clear	B	s	501	RGB	RGB	m	97.3-2014mm 83.3mm increments	IP40	40	50mm/1.97"	0050	Single no sheath tail	S00X	DC 24V	g
		Diffused	C											300mm/11.81"	0300	Double no sheath tail	D00X		
		Silver Anodised (white endcaps)	SAWE							i	3.83-79.29in 3.28in increments			1000mm/39.37"	1000	Single no sheath IP20 connector	S20X		
											(Specify length code OR total run length)					Double no sheath IP20 connector	D20X		

¹ Refer to **End Cap Options** on **Options** pages

² Refer to **Cover/Lens Options** on **Options** pages

³ Refer to **Length Availability List** or enter total run length instead of length code

⁴ Refer to **Power Feed Options** on **Options** pages

Code Example:

LS	-	SA	-	C	-	s	-	501	-	RGB	-	m	-	514	-	40	-	0300	-	D00X	-	g
LINE-S		Silver Anodised (grey endcaps)		Diffused				501		RGB				513.8mm		IP40		300mm/11.81"		Double no sheath tail		DC 24V

ACCESSORIES

Mounting Accessories

KKCP-10 Concealed Clip

* Refer to **Mounting accessories** on **Accessories** pages

Connection Accessories

KKCN-07 4 PIN RGB male & female 50mm/1.97" pair

KKCN-09 4 PIN RGB male & female 300mm/11.81" pair

KKCN-11 4 PIN RGB 300mm/11.81" extension lead

* Refer to **Power feed** on **Accessories** pages

PSU/Driver

0-10V/1-10V/DALI/DMX

* Refer to **Driver/PSU Options** page for details or provide requirement and KKDC to offer the suitable option

LED ENGINE VARIANTS (LED STRIP TYPE)

Colour	LED	Lumen/m	Lumen/ft	W/m	W/ft	Spec Doc	Length	Increment
Single CCT	R007	564	172	7	2.13	LINE-S R007	97-2014mm (3.81-79.29in)	41.7mm (1.64in)
	R014	1158	353	14	4.27	LINE-S R014	97-2014mm (3.81-79.29in)	41.7mm (1.64in)
	R020	1632	498	20	6.10	LINE-S R020	97-2014mm (3.81-79.29in)	41.7mm (1.64in)
Warm Dim/Dynamic White	R207	1323	403	16	4.88	LINE-S R207	97-2014mm (3.81-79.29in)	83.3mm (3.28in)
RGB	501	Red 134 Green 284 Blue 46 RGB 423	Red 41 Green 87 Blue 14 RGB 129	15.6	4.75	LINE-S RGB	97-2014mm (3.81-79.29in)	83.3mm (3.28in)

* Performance data: clear cover. RGB

LINE-S RGB

Length Availability List



Length Code		Fixture Length ¹		LED Strip ²		End Cap Dimension ³		Wattage (W)	Output (lm)			
Metric	Imperial(US)	Metric	Imperial(US)	Metric	Imperial(US)	Metric	Imperial(US)		R	G	B	W
m0097	i0004	97mm	3.83in	83mm	3.28in	4mm	0.16in	1.30	11	24	4	35
m0181	i0007	181mm	7.11in	167mm	6.56in	4mm	0.16in	2.60	22	47	8	71
m0264	i0010	264mm	10.39in	250mm	9.84in	4mm	0.16in	3.90	34	71	12	106
m0347	i0014	347mm	13.68in	333mm	13.12in	4mm	0.16in	5.20	45	95	15	141
m0431	i0017	431mm	16.96in	417mm	16.41in	4mm	0.16in	6.50	56	118	19	176
m0514	i0020	514mm	20.24in	500mm	19.69in	4mm	0.16in	7.80	67	142	23	212
m0597	i0024	597mm	23.52in	583mm	22.97in	4mm	0.16in	9.10	78	166	27	247
m0681	i0027	681mm	26.80in	667mm	26.25in	4mm	0.16in	10.40	89	189	31	282
m0764	i0030	764mm	30.08in	750mm	29.53in	4mm	0.16in	11.70	101	213	35	317
m0847	i0033	847mm	33.36in	833mm	32.81in	4mm	0.16in	13.00	112	237	38	353
m0931	i0037	931mm	36.64in	917mm	36.09in	4mm	0.16in	14.30	123	260	42	388
m1014	i0040	1014mm	39.92in	1000mm	39.37in	4mm	0.16in	15.60	134	284	46	423
m1097	i0043	1097mm	43.21in	1083mm	42.65in	4mm	0.16in	16.90	145	308	50	458
m1181	i0046	1181mm	46.49in	1167mm	45.94in	4mm	0.16in	18.20	156	331	54	494
m1264	i0050	1264mm	49.77in	1250mm	49.22in	4mm	0.16in	19.50	168	355	58	529
m1347	i0053	1347mm	53.05in	1333mm	52.50in	4mm	0.16in	20.80	179	379	61	564
m1431	i0056	1431mm	56.33in	1417mm	55.78in	4mm	0.16in	22.10	190	402	65	599
m1514	i0060	1514mm	59.61in	1500mm	59.06in	4mm	0.16in	23.40	201	426	69	635
m1597	i0063	1597mm	62.89in	1583mm	62.34in	4mm	0.16in	24.70	212	450	73	670
m1681	i0066	1681mm	66.17in	1667mm	65.62in	4mm	0.16in	26.00	223	473	77	705
m1764	i0069	1764mm	69.45in	1750mm	68.90in	4mm	0.16in	27.30	235	497	81	740
m1847	i0073	1847mm	72.74in	1833mm	72.18in	4mm	0.16in	28.60	246	521	84	776
m1931	i0076	1931mm	76.02in	1917mm	75.47in	4mm	0.16in	29.90	257	544	88	811
m2014	i0079	2014mm	79.30in	2000mm	78.75in	4mm	0.16in	31.20	268	568	92	846

¹ Actual total overall length of light fixture (LED strip + end caps + void/wire hole)

² Actual length of PCB strip

³ Actual length of 2x end caps

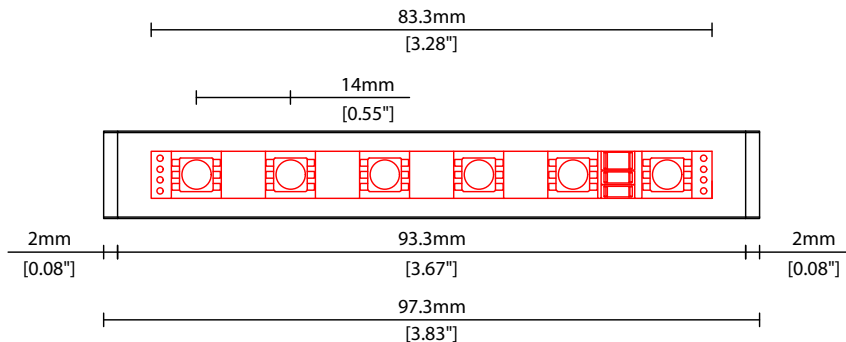



LINI-S RGB Options



COVER/LENS OPTIONS

* Options are an integral part of the fixture ordering codes. Please refer to **Code Table** pages.

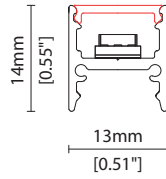

B Clear cover
W13/H14(W0.51/H0.55in)

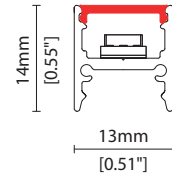

C Diffused cover
W13/H14(W0.51/H0.55in)

END CAP OPTIONS



SA Silver anodised finish
with grey end caps.

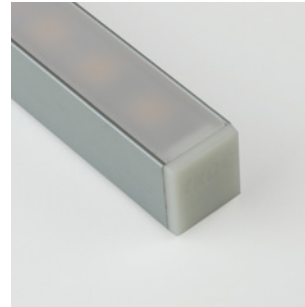

SAWE Silver anodised finish
with white end caps.

POWER FEED OPTIONS

* Options are an integral part of the fixture ordering codes. Please refer to **Code Table** pages.

0050 S20X 50mm (1.97") Single no sheath IP20 connector

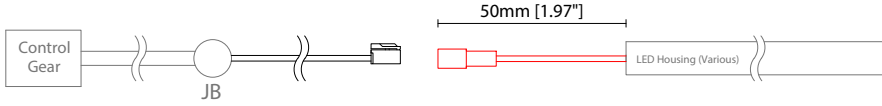

0050 D20X 50mm (1.97") Double no sheath IP20 connector

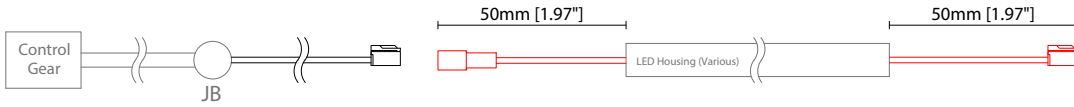

0300 S00X 300mm (11.81") Single no sheath tail

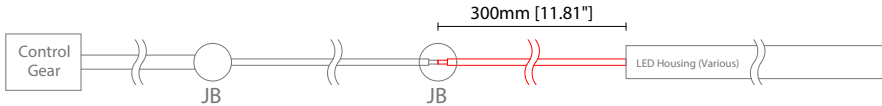

0300 D00X 300mm (11.81") Double no sheath tail

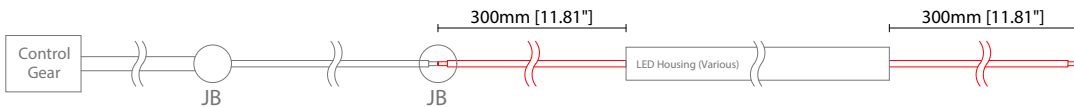

0300 S20X 300mm (11.81") Single no sheath IP20 connector

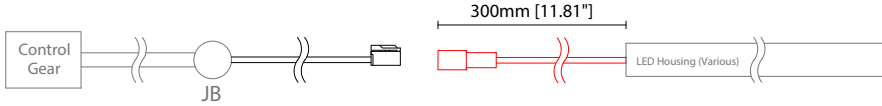

0300 D20X 300mm (11.81") Double no sheath IP20 connector

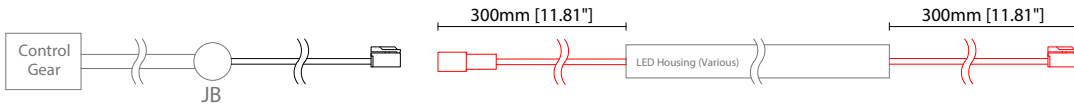

1000 S00X 1000mm (39.37") Single no sheath tail

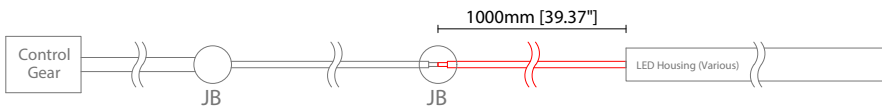

1000 D00X 1000mm (39.37") Double no sheath tail

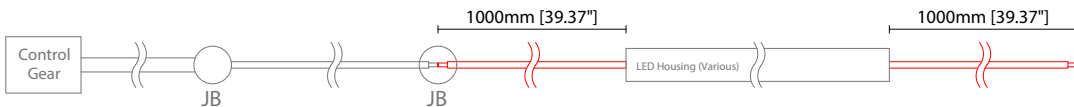

1000 S20X 1000mm (39.37") Single no sheath IP20 connector

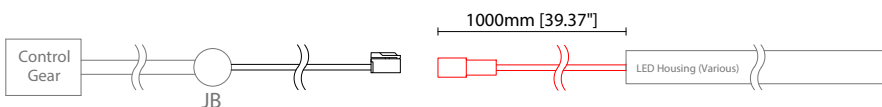

Key

Control Gear Power supply, sub-controllers & control systems

JB Junction box / cable connection

POWER FEED OPTIONS (CONTINUED)

1000 D20X 1000mm (39.37") Double no sheath IP20 connector

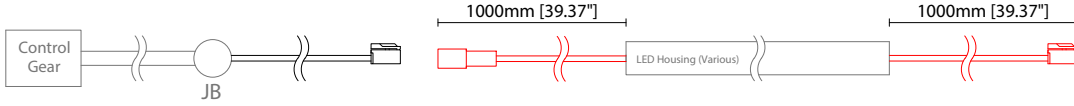

4 Pin RGB Female Connector

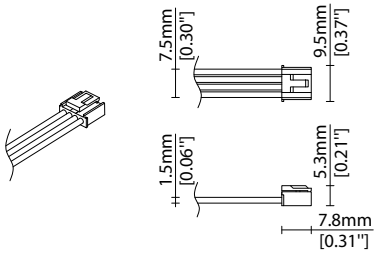

4 Pin RGB Male Connector

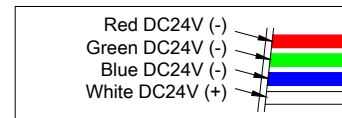
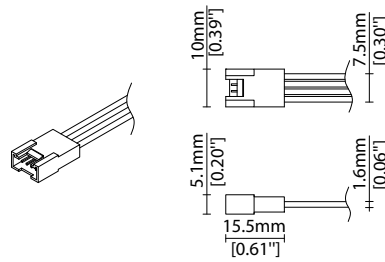

Key

Control Gear Power supply, sub-controllers & control systems
 JB Junction box / cable connection

MOUNTING ACCESSORIES

Note: Accessories are to be ordered separately with corresponding code shown below.

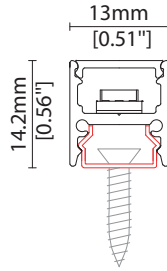

KKCP-10

Concealed clip
(allow 3 per metre/40in)
S/Steel finish
L20/W13/H14.2mm
(L0.79/W0.51/H0.56")

POWER FEED

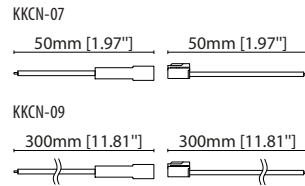
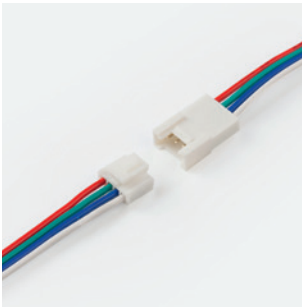

KKCN-07 50mm (1.97in) pair
KKCN-09 300mm (11.81in) pair
4 PIN RGB male + female
connector set

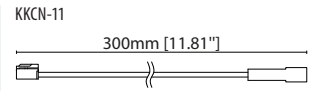

KKCN-11
4 PIN RGB 300mm (11.81in)
extension lead

KKDC CONTROL



IP20
Plastic housing
L170/W59/H29mm
(L6.69/W2.32/H1.14in)

KKDM-06 1-10V
visDIM dimmable sub-controller
(4 x 8A max @ 12-36V)



IP20
Plastic housing
L170/W53.4/H28mm
(L6.69/W2.10/H1.10in)

KKSC-05 DMX
visDIM dimmable sub-controller
(4 x 5A max @ 12-36V)

KKDC CONTROL (CONTINUED)



IP20
Plastic housing
L170/W59/H29mm
(L6.69/W2.32/H1.14in)

KKDL-02 DALI

visDIM dimmable sub-controller
(4 x 8A max @ 12-36V)



IP20
Plastic housing
L166/W53.4/H23mm
(L6.54/W2.10/H0.91in)

KKDL-03 DALI

visDIM dimmable sub-controller
(4 x 5A max @ 12-36V)

AVAILABLE PSU OPTIONS

Control Mode	PSU (Order Code)	Input Voltage AC	Output Voltage DC	Rated Output Current	Rated Power	Dim %	IP Rating
Switched	CEN-60-24	90-295V	24V	2.5A	60W	-	IP67
	HLG-60H-24	90-305V	24V	2.5A	60W	-	IP67
	HLG-100H-24	90-305V	24V	4.0A	100W	-	IP67
	HLG-150H-24	90-305V	24V	6.3A	150W	-	IP67
	HLG-240H-24	90-305V	24V	10A	240W	-	IP67
0-10V (1-10V)	PWM-40-24	90-305V	24V	1.67A	40W	100-0.15 (100-10)	IP67
	PWM-60-24	90-305V	24V	2.5A	60W	100-0.15 (100-10)	IP67
	PWM-90-24	90-305V	24V	3.67A	90W	100-0.15 (100-10)	IP67
	PWM-120-24	90-305V	24V	5.0A	120W	100-0.15 (100-10)	IP67
DALI	LIN100A1	120-277V	24V	1A per channel	100W	100-0.1	IP66/IP40
DMX RGB	LIN100A1	120-277V	24V	1.33A per channel	100W	100-0.1	IP66/IP40
DMX RGBW	LIN100A1	120-277A	24V	1A per channel	100W	100-0.1	IP66/IP40

Flicker Free Options - Combination of PSU+ sub-controller

Control Mode	PSU (Order Code)	Sub-controller (Order Code)	Input Voltage AC	Output Voltage DC	Rated Output Current	Rated Power	Dim %	IP Rating PSU/ Sub-controller
0-10V or 1-10V	CEN-60-24	KKDM-06	90-295V	24V	2.5A	60W	100-0.9	IP67/IP20
	HLG-60H-24	KKDM-06	90-295V	24V	2.5A	60W	100-0.9	IP67/IP20
	HLG-100H-24	KKDM-06	90-295V	24V	4.0A	100W	100-0.9	IP67/IP20
	HLG-150H-24	KKDM-06	90-295V	24V	6.3A	150W	100-0.9	IP67/IP20
	HLG-240H-24	KKDM-06	90-295V	24V	10.0A	240W	100-0.9	IP67/IP20
DALI	CEN-60-24	KKDL-02/03	90-295V	24V	2.5A	60W	100-0.1	IP67/IP20
	HLG-60H-24	KKDL-02/03	90-305V	24V	2.5A	60W	100-0.1	IP67/IP20
	HLG-100H-24	KKDL-02/03	90-305V	24V	4.0A	100W	100-0.1	IP67/IP20
	HLG-150H-24	KKDL-02/03	90-305V	24V	6.3A	150W	100-0.1	IP67/IP20
	HLG-240H-24	KKDL-02/03	90-305V	24V	10.0A	240W	100-0.1	IP67/IP20
DMX RGB	CEN-60-24	KKSC-05	90-295V	24V	2.5A	60W	100-0.9	IP67/IP20
	HLG-60H-24	KKSC-05	90-305V	24V	2.5A	60W	100-0.9	IP67/IP20
	HLG-100H-24	KKSC-05	90-305V	24V	4A	100W	100-0.9	IP67/IP20
	HLG-150H-24	KKSC-05	90-305V	24V	6.3A	150W	100-0.9	IP67/IP20
	HLG-240H-24	KKSC-05	90-305V	24V	10.0A	240W	100-0.9	IP67/IP20

¹ The items shown above cover the most frequently used specification but does not exhaust the possible options

² PSU and/or driver can be chosen from the table, or KKDC may recommend the best option upon receipt of the controls requirement and installation environment

³ Electrical shop drawing will include detailed information of PSU and relevant control drivers

⁴ Cut sheets are available on the controls section of www.kkdc.lighting or upon request